

EURO-NORM **basicline**





basicline - Versatile, Flexible, Universal!

basicline is a high-quality Euro norm series for the food and non-food sector. On account of the diversity of variants, the light, yet very stable containers made of PP-C (polypropylene copolymer) are perfectly suited to almost every application.

As such it is possible to combine various bases as required, including closed or perforated side walls, closed or open handgrips and suitable accessories. It is not just the functionality of basicline that convinces the user, the containers' appearance is also valued. Curved shapes and the characteristic pattern of the perforated version give the containers their typical design.



basicline - Plus Points at a Glance!

- + available in the basic sizes 200 x 150 mm, 300 x 200 mm, 400 x 300 mm and 600 x 400 mm
- + in six different heights
- + easy to clean and as such, ideal for food logistics
- + available as a closed and perforated version
- + suitable for manual handling and automatic conveyor technology
- + stability as a result of a strengthened frame and corner construction
- + fitted with ergonomically shaped handles
- + made from PP-C (polypropylene copolymer)
- + 100 % recyclable

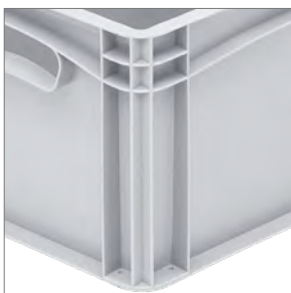

Stable Corner



Closed Handgrip



Open Handgrip



Easy to Clean Surfaces



closed, smooth base

Load Capacity
up to

20 kg

Article No.

xxxx/0003xx

closed, smooth base, with
drainage holes for water

20 kg

xxxx/0003xx

ribbed, perforated base

30 kg

xxxx/3300xx

ribbed, closed base

30 kg

xxxx/0000xx

Expandable in a variety of ways

Suitable insert containers, glass inserts and transportation trolleys are available for the basicline Euro-standard containers, which you will find in the chapter 'Accessories'.

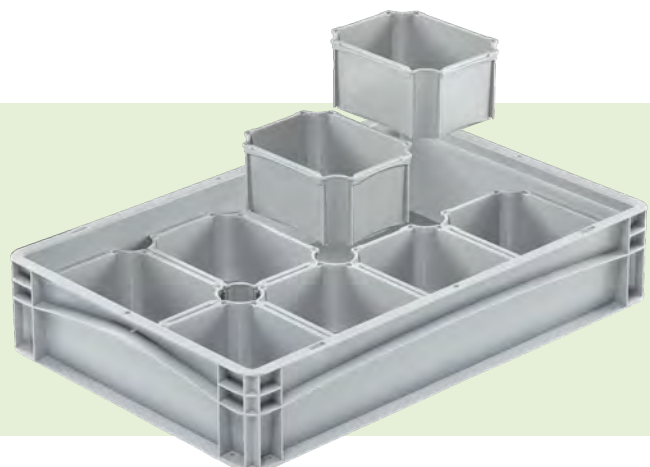



„basicline mini” - Perfect for All Small Items

The small basicline containers are the perfect helpers to keep things neat and tidy. With their base dimensions of 200 x 150 mm and 300 x 200 mm, they are ideal for sorting and storing small parts. To ensure that everything is stored safely and dust-proof, loose, click and hinge lids are available for the small containers.

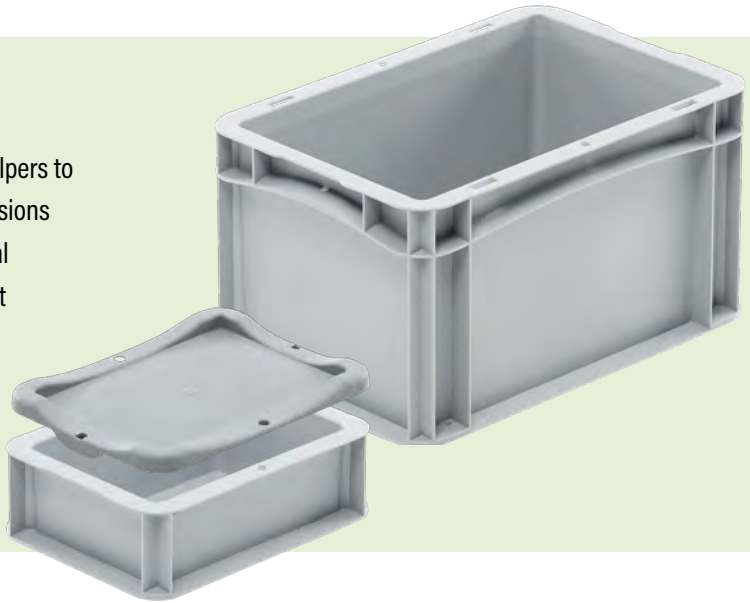







	Outer Dimensions (in mm)	Sides		Bottom			Handgrips		Volume	Weight	Article No.	
	Inner Dimensions (in mm)	closed	perforated	closed, smooth base	closed, smooth base, with drainage holes for water	ribbed, closed base	ribbed, perforated base	closed handgrips				open handgrips
	200 x 150 x 70 168 x 118 x 68	✓		✓				✓		1.3 l	130 g	0721/000300
	200 x 150 x 120 168 x 118 x 118	✓		✓				✓		2.2 l	200 g	1221/000300
	300 x 200 x 70 268 x 168 x 68	✓		✓				✓		2.9 l	240 g	0731/000300
	300 x 200 x 120 268 x 168 x 118	✓		✓				✓		5.1 l	340 g	1231/000300
	300 x 200 x 170 268 x 168 x 168	✓		✓				✓		7.2 l	435 g	1731/000300
	300 x 200 x 220 268 x 168 x 218	✓		✓				✓		9.4 l	510 g	2231/000300







„basicline mini“ Translucent - Clear Overview and Organisation

All basicline mini containers are also available in translucent material. The appropriate lids are exceptionally transparent due to their smooth polished surface. At first glance, it is clear what is stored in the small boxes.









Outer Dimensions (in mm)	Sides		Bottom				Handgrips		Volume	Weight	Article No.	
	Inner Dimensions (in mm)	closed	perforated	closed, smooth base	closed, smooth base, with drainage holes for water	ribbed	closed base	ribbed, perforated base				closed handgrips
 200 x 150 x 70 168 x 118 x 68	✓		✓					✓		1.3 l	130 g	0721/000300
 200 x 150 x 120 168 x 118 x 118	✓		✓					✓		2.2 l	200 g	1221/000300
 300 x 200 x 70 268 x 168 x 68	✓		✓					✓		2.9 l	240 g	0731/000300
 300 x 200 x 120 268 x 168 x 118	✓		✓					✓		5.1 l	340 g	1231/000300
 300 x 200 x 170 268 x 168 x 168	✓		✓					✓		7.2 l	435 g	1731/000300
 300 x 200 x 220 268 x 168 x 218	✓		✓					✓		9.4 l	510 g	2231/000300









	Outer Dimensions (in mm)	Sides		Bottom			Handgrips		Volume	Weight	Article No.	
	Inner Dimensions (in mm)	closed	perforated	closed, smooth base	closed, smooth base, with drainage holes for water	ribbed, closed base	ribbed, perforated base	closed handgrips				open handgrips
	400 x 300 x 70 367 x 268 x 67	✓		✓				✓		6.4 l	470 g	0741/000300
	400 x 300 x 120 367 x 268 x 117	✓		✓				✓		11.2 l	690 g	1241/000300
	400 x 300 x 170	✓		✓				✓	✓	15.9 l	850 g	1742/000300
	367 x 268 x 167	✓		✓				✓		15.9 l	850 g	1741/000300
	400 x 300 x 220	✓		✓				✓	✓	20.8 l	1,030 g	2242/000300
	367 x 268 x 217	✓		✓				✓		20.8 l	1,030 g	2241/000300
	400 x 300 x 270	✓		✓				✓	✓	25.6 l	1,300 g	2742/000300
	367 x 268 x 267	✓		✓				✓		25.6 l	1,300 g	2741/000300
		✓					✓		✓	25.6 l	1,310 g	2742/000000
	400 x 300 x 320	✓		✓				✓	✓	30 l	1,460 g	3242/000300
	367 x 268 x 317	✓		✓				✓		30 l	1,460 g	3241/000300
		✓					✓		✓	30 l	1,520 g	3242/000000









	Outer Dimensions (in mm)	Sides		Bottom			Handgrips		Volume	Weight	Article No.
	Inner Dimensions (in mm)	closed	perforated	closed, smooth base	closed, smooth base, with drainage holes for water	ribbed, closed base	ribbed, perforated base	closed handgrips			
	400 x 300 x 70 367 x 268 x 58		✓				✓	✓	5.4 l	470 g	0741-330000
	400 x 300 x 120 367 x 268 x 108		✓				✓	✓	10.2 l	680 g	1241-330000
	400 x 300 x 170 367 x 268 x 158		✓				✓	✓	14.9 l	820 g	1742.330000
	400 x 300 x 220 367 x 268 x 208		✓				✓	✓	19.8 l	920 g	2242.330000
	400 x 300 x 270 367 x 268 x 258		✓				✓	✓	24.6 l	1,140 g	2742.330000
	400 x 300 x 320 367 x 268 x 308		✓				✓	✓	29.0 l	1,280 g	3242.330000

▪ = Variants are available, but are not continuously in stock





	Outer Dimensions (in mm)	Sides		Bottom			Handgrips		Volume	Weight	Article No.	
	Inner Dimensions (in mm)	closed	perforated	closed, smooth base	closed, smooth base, with drainage holes for water	ribbed, closed base	ribbed, perforated base	closed handgrips				open handgrips
	600 x 400 x 70 567 x 367 x 67	✓		✓				✓		13.7 l	830 g	0761/000300
	600 x 400 x 120 567 x 367 x 117	✓		✓				✓		23.9 l	1,140 g	1261/000300
	600 x 400 x 170 567 x 367 x 167	✓ ✓		✓ ✓				✓	✓	35.6 l 35.6 l	1,390 g 1,390 g	1762/000300 1761/000300
	600 x 400 x 220 567 x 367 x 217	✓ ✓		✓ ✓				✓	✓	44.2 l 44.2 l	1,650 g 1,650 g	2262/000300 2261/000300
	600 x 400 x 270 567 x 367 x 267	✓ ✓		✓ ✓				✓	✓	54.4 l 54.4 l	1,960 g 1,960 g	2762/000300 2761/000300
	600 x 400 x 320 567 x 367 x 317	✓ ✓		✓ ✓				✓	✓	64.5 l 64.5 l	2,200 g 2,200 g	3262/000300 3261/000300



	Outer Dimensions (in mm)	Sides		Bottom				Handgrips		Volume	Weight	Article No.
	Inner Dimensions (in mm)	closed	perforated	closed, smooth base	closed, smooth base, with drainage holes for water	ribbed, closed base	ribbed, perforated base	closed handgrips	open handgrips			
	600 x 400 x 70 567 x 367 x 55		✓					✓	✓	11.2 l	900 g	0761.330000
	600 x 400 x 120 567 x 367 x 105		✓					✓	✓	21.4 l	1,160 g	1261.330000
	600 x 400 x 170 567 x 367 x 155		✓					✓	✓	33.1 l	1,400 g	1762.330000
	600 x 400 x 220 567 x 367 x 205		✓					✓	✓	41.7 l	1,570 g	2262.330000
	600 x 400 x 270 567 x 367 x 255		✓					✓	✓	51.9 l	1,820 g	2762.330000
	600 x 400 x 320 567 x 367 x 305		✓					✓	✓	62.0 l	1,940 g	3262.330000

▪ = Variants are available, but are not continuously in stock







Outer Dimensions (in mm)	Sides		Bottom				Handgrips		Volume	Weight	Article No.
	closed	perforated	closed, smooth base	closed, smooth base, with drainage holes for water	ribbed, closed base	ribbed, perforated base	closed handgrips	open handgrips			
Inner Dimensions (in mm)											
 400 x 300 x 220 367 x 268 x 217	✓		✓				✓		20.8 l	970 g	2243/000300
 400 x 300 x 270 367 x 268 x 267	✓		✓				✓		25.6 l	1,180 g	2743/000300
 400 x 300 x 320 367 x 268 x 317	✓		✓				✓		30 l	1,360 g	3243/000300







	Outer Dimensions (in mm)	Sides		Bottom			Handgrips		Volume	Weight	Article No.	
	Inner Dimensions (in mm)	closed	perforated	closed, smooth base	closed, smooth base, with drainage holes for water	ribbed, closed base	ribbed, perforated base	closed handgrips				open handgrips
	600 x 400 x 220 567 x 367 x 217	✓		✓				✓		44.2 l	1,540 g	2263/000300
	600 x 400 x 270 567 x 367 x 267	✓		✓				✓		54.4 l	1,860 g	2763/000300
	600 x 400 x 320 567 x 367 x 317	✓		✓				✓		64.5 l	2,070 g	3263/000300
	600 x 400 x 220 567 x 367 x 217	✓		✓				✓		44.2 l	1,670 g	2264/000300
	600 x 400 x 270 567 x 367 x 267	✓		✓				✓		54.4 l	2,030 g	2764/000300
	600 x 400 x 320 567 x 367 x 317	✓		✓				✓		64.5 l	2,280 g	3264/000300



	Outer Dimensions (in mm)	Description	Weight	Article No.
200 x 150 mm				
	200 x 150	Click lid, without container	58 g	0016
300 x 200 mm				
	300 x 200	Click lid, without container	135 g	0066
400 x 300 mm				
	400 x 300	Loose lid, without container	320 g	0078
600 x 400 mm				
	600 x 400	Loose lid, without container	625 g	0077



	Outer Dimensions (in mm)	Description	Weight	Article No.
200 x 150 mm				
	200 x 150	Click lid, without container	58 g	0016
300 x 200 mm				
	300 x 200	Click lid, without container	135 g	0066
400 x 300 mm				
	400 x 300	Loose lid, without container	240 g	0097
600 x 400 mm				
	600 x 400	Loose lid, without container	480 g	0098



	Outer Dimensions (in mm)	Description	Weight	Article No.
200 x 300 mm				
	200 x 300	Hinged lid with assembly accessories consisting of two grey hinges and two blue locking bars, pre-mounted on the lid	135 g	0069
400 x 300 mm				
	400 x 300	Hinged lid with assembly accessories consisting of two grey hinges and two blue locking bars, pre-mounted on the lid	320 g	0081
600 x 400 mm				
	600 x 400	Hinged lid with assembly accessories consisting of two grey hinges and two blue locking bars, pre-mounted on the lid	635 g	0082
Assembly Accessories				Article No.
		Assembly accessories - standard Locking bar, per piece Hinge, per piece	7240 7242	
		Assembly accessories Hinge, per piece	7241	



	Outer Dimensions (in mm)	Description	Weight	Article No.
200 x 300 mm				
	200 x 300	Hinged lid with assembly accessories consisting of two white hinges and two white locking bars, pre-mounted on the lid	135 g	0069
400 x 300 mm				
	400 x 300	Hinged lid with assembly accessories consisting of two white hinges and two white locking bars, pre-mounted on the lid	260 g	0091
600 x 400 mm				
	600 x 400	Hinged lid with assembly accessories consisting of two white hinges and two white locking bars, pre-mounted on the lid	480 g	0092
Assembly Accessories				Article No.
		Assembly accessories - standard Locking bar, per piece Hinge, per piece	7240 7242	
		Assembly accessories Hinge, per piece	7241	



bekuplast GmbH · Industriestraße 1 · 49824 Ringe · Germany
+49 5944 9333-0 · info@bekuplast.com · www.bekuplast.com